



## Cordless Sweeper

### OWNER'S MANUAL

Model V1725HY  
4.8 Volt DC



For information or assistance:

**EURO-PRO Operating LLC Operating LLC**  
94 Main Mill Street, Door 16  
Plattsburgh, NY 12901  
Tel: 1 (800) 798-7398



### ONE (1) YEAR LIMITED WARRANTY

EURO-PRO Operating LLC warrants this product to be free from defects in material and workmanship for a period of one (1) year from the date of the original purchase, when utilized for normal household use, subject to the following conditions, exclusions and exceptions.

If your appliance fails to operate properly while in use under normal household conditions within the warranty period, return the complete appliance and accessories, freight prepaid to:

**EURO-PRO Operating LLC**, 94 Main Mill street, Door 16, Plattsburgh, N.Y. 12901

If the appliance is found by **EURO-PRO Operating LLC** to be defective in material or workmanship, **EURO-PRO Operating LLC** will repair or replace it free of charge. Proof of purchase date and \$ 9.95 to cover the cost of return shipping and handling must be included. \*

Non-durable parts including, without limitation, dust cups and brushes which normally require replacement are specifically excluded from warranty.

The liability of **EURO-PRO Operating LLC** is limited solely to the cost of the repair or replacement of the unit at our option. This warranty does not cover normal wear of parts and does not apply to any unit that has been tampered with or used for commercial purposes. This limited warranty does not cover damage caused by misuse, abuse, negligent handling or damage due to faulty packaging or mishandling in transit. This warranty does not cover damage or defects caused by or resulting from damages from shipping or repairs, service or alterations to the product or any of its parts, which have been performed by a repair person not authorized by **EURO-PRO Operating LLC**.

This warranty is extended to the original purchaser of the unit and excludes all other legal and/or conventional warranties. The responsibility of **EURO-PRO Operating LLC** if any, is limited to the specific obligations expressly assumed by it under the terms of the limited warranty. **In no event is EURO-PRO Operating LLC** liable for incidental or consequential damages of any nature whatsoever. Some states do not permit the exclusion or limitation of incidental or consequential damages, so the above may not apply to you.

This warranty gives you specific legal rights, and you may also have other rights which vary from province to province.

**\*Important: Carefully pack item to avoid damage in shipping. Be sure to include proof of purchase date and to attach tag to item before packing with your name, complete address and phone number with a note giving purchase information, model number and what you believe is the problem with item. We recommend you insure the package (as damage in shipping is not covered by your warranty). Mark the outside of your package "ATTENTION CUSTOMER SERVICE". We are constantly striving to improve our products, therefore the specifications contained herein are subject to change without notice.**



#### OWNERSHIP REGISTRATION CARD

Please fill out and mail the product registration card within ten (10) days of purchase. The registration will enable us to contact you in the unlikely event of a product safety notification. By returning this card you acknowledge to have read and understood the instructions for use, and warnings set forth in the accompanying instructions.

**RETURN TO: EURO-PRO Operating LLC**, 94 main Mill Street, Door 16, Plattsburgh, N.Y. 12901

**V1725HY**  
 \_\_\_\_\_  
**Appliance model**

\_\_\_\_\_

**Date purchased** \_\_\_\_\_ **Name of store** \_\_\_\_\_

\_\_\_\_\_

**Owner's name**

\_\_\_\_\_

**Address** \_\_\_\_\_ **City** \_\_\_\_\_ **State** \_\_\_\_\_ **Zip Code** \_\_\_\_\_

## Attaching Wipes to Wipe Attachment

To attach wipes to the floor attachment: simply place the wipe on floor with the cling strip facing up. Align the cling strip on the floor attachment with the cling strip on the wipe and press down to attach. Always keep the zipper bag sealed to keep the wipes moist.

To detach wipe from floor attachment: gently pull off and dispose of in the trash. **Do NOT** flush!

**Note:** **Do not** use the wipes for wood floors on unfinished wood boards, non-sealed tiles or carpeting.

**Do not** use the multi purpose wipes on unfinished, oiled or waxed wood floors or on non-sealed tiles.

## Care and Maintenance

To improve the performance and life of your unit, we recommend you do the following:

1. Once a month clean the unit with a dry cloth, including the chamber which the dust container fits into. Remove any hair, fiber or other materials that may have built up in the chamber, on the rotating brush.
2. Don't use abrasive materials to clean the sweeper. **Do not immerse the unit in water.**
3. Do not pick up liquids or use on wet floors.
4. Do not use on concrete, tar or similar rough surfaces .
5. Don't pick up pieces of string or fabrics with the sweeper.
6. Do not clean tasseled or frayed carpets with the sweeper.

TROUBLESHOOTING GUIDE		
PROBLEM	POSSIBLE REASON	POSSIBLE SOLUTION
SWEeper WILL NOT OPERATE	<ol style="list-style-type: none"> <li>1. Batteries discharged.</li> <li>2. No power in electrical outlet supplying charging adapter.</li> <li>3. Unit needs servicing.</li> <li>4. Battery misplaced.</li> </ol>	<ol style="list-style-type: none"> <li>1. Charge unit.</li> <li>2. Check fuse or breaker. Replace fuse/reset breaker.</li> <li>3. Call Customer Service.</li> <li>4. Match "+" on battery to compartment "+".</li> </ol>
SWEeper WILL NOT PICK-UP	<ol style="list-style-type: none"> <li>1. Dust container is full.</li> <li>2. Unit needs recharging.</li> </ol>	<ol style="list-style-type: none"> <li>1. Empty dust container.</li> <li>2. Charge unit.</li> </ol>
DUST ESCAPING FROM SWEeper	<ol style="list-style-type: none"> <li>1. Dust container is full.</li> </ol>	<ol style="list-style-type: none"> <li>1. Empty dust container.</li> </ol>
ROTATING BRUSH WILL NOT PICK UP	<ol style="list-style-type: none"> <li>1. Unit clogged.</li> <li>2. Dust container is full.</li> </ol>	<ol style="list-style-type: none"> <li>1. Check for excessive material on brush or in bottom of sweeper. Remove obstruction from brushes and/or sweeper.</li> <li>2. Empty and clean dust container.</li> </ol>
SWEeper WILL NOT CHARGE	<ol style="list-style-type: none"> <li>1. Electrical outlet not working.</li> <li>2. Charging Adapter not working.</li> <li>3. Batteries no longer functioning.</li> <li>4. Unit left in on position.</li> </ol>	<ol style="list-style-type: none"> <li>1. Check to ensure outlet is working properly. (Easily checked by plugging in another appliance.</li> <li>2. Replace charging adapter.</li> <li>3. See battery disposal pg. 7.</li> <li>4. Press switch to "Off".</li> </ol>

## IMPORTANT SAFEGUARDS

When using an electrical appliance, basic safety precautions should always be observed, including the following

**READ ALL INSTRUCTIONS BEFORE USING YOUR CORDLESS SWEEPER.**

**WARNING:** To reduce the risk of fire, electrical shock, or injury:

1. Do not charge this unit outdoors.
2. Do not use outdoors or on wet surfaces.
3. Do not allow to be used as a toy. Close attention is necessary when used by or near children.
4. Use only as described in this manual. Use only manufacturer's recommended attachments.
5. Do not use with damaged cord or plug. Do not use cordless sweeper if it has been dropped, damaged, left outdoors, or dropped in water. Return it to **EURO-PRO Operating LLC** for examination, repair or adjustment.
6. Do not abuse the charger cord. Never carry the charger or base by the cord or yank to disconnect from an outlet; instead grasp the charger and pull to disconnect.
7. Keep charger cord away from heated surfaces.
8. This product includes rechargeable nickel cadmium batteries. Batteries must be recycled or disposed of properly. **Do not incinerate batteries or expose to high temperatures.** as they may explode.
9. Do not handle plug or appliance with wet hands.
10. Do not put any object into openings. Do not use with any opening blocked; keep free of dust, lint, hair and anything that may reduce air flow.
11. Keep hair, loose clothing, fingers, and all parts of body away from openings and moving parts.
12. Do not pick up anything that is burning or smoking, such as cigarettes, matches, or hot ashes.
13. Do not attempt to change accessories while unit is running.
14. Use extra care when cleaning on stairs.
15. Do not use to pick up flammable or combustible liquids such as gasoline or use in areas where they may be present.
16. Read and follow all label, operational and marking instructions.
17. Do not use charger with an extension cord. Plug charger directly into an electrical outlet. Use charger only in a standard (120V., 60Hz) electrical outlet.
18. **Do not use the cordless sweeper without dust container in place.**
19. Store the cordless sweeper indoors. Store after use to prevent accidents.
20. Leaks from battery cells can occur under extreme conditions. If the liquid, which is 20-35% solution of potassium hydroxide, gets on the skin - wash immediately with soap and water or neutralize with a mild acid such as lemon juice or vinegar. If the liquid gets into the eyes, flush them immediately with clean water for a minimum of 10 minutes and seek medical attention.
21. Use only on dry, indoor surfaces.
22. Do not use for any purpose other than described in this user's guide.
23. Do not attempt to use the charger with any other product or attempt to charge this product with another charger. **Use only charger model TechWorld AD-0720-UL-8 OR AD-0815-UL8 supplied with this appliance.**
24. The appliance must be disconnected from the supply when removing the battery.

**SAVE THESE INSTRUCTIONS  
FOR HOUSEHOLD USE ONLY**



**Model: V1725HY**  
**4.8 Volt DC**

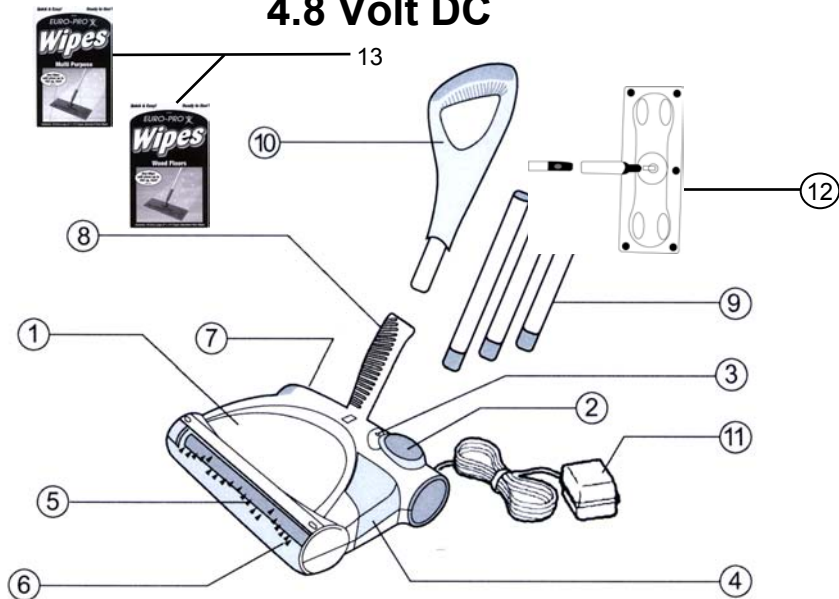

- |                             |  |
|-----------------------------|--|
| 1. Sweeper Power Head       | 8. Lower Handle  |
| 2. On / Off Switch          | 9. Metal Extension Handles   |
| 3. Charging Light Indicator | 10. Upper Handle   |
| 4. Dust Cup (Container)     | 11. Charging Adapter: Use Only<br>TechWorld AD-0720-UL-8 7,V-200 mA<br>or AD-0815-UL8 7,5V-150mA |
| 5. Rotating Brush           | 12. Floor Attachment   |
| 6. Transparent Brush Cover  | 13. Multi-purpose and wood floor wipes   |
| 7. Charging Jack            |  |

Illustrations may differ from actual product.

**NOTE:** Cordless Sweeper Model V1725H is shipped with the batteries uncharged. Charging of the unit for 20 hours prior to first use is required. Use replacement battery # X9725H only.

## Battery Removal & Disposal

**NOTE:** If uncertain as to how to remove your battery pack, we suggest you take your sweeper to a reputable small appliance service technician to have this service performed.

Follow these steps when battery removal is required.

This sweeper is equipped with Ni-Cd batteries and you need to dispose of them properly. When the batteries are no longer good for use, they must be removed from the sweeper for disposal. Do not remove the batteries for any reason other than disposal of them. **Call your nearest recycling center for information on the recycling and disposal of Ni-Cd batteries.**

**WARNING:** You must never use ordinary batteries for replacement as these may leak and cause damage. Use only battery pack **X9725H** provided by **EURO-PRO Operating LLC** for replacement.

## Removal of Battery Pack

1. Remove the extension handles and dust cup container.
2. Turn unit over so that the base is facing upwards. Be careful not to turn the unit ON. (Fig. 10)
3. Push in locking tab and lift off battery compartment cover. (Fig. 11)
4. Lift out battery pack and set aside.
5. Insert the new battery pack into unit, ensuring that the Positive (+) terminal of the battery pack corresponds with the positive (+) making inside the battery compartment. Replace the battery compartment cover making certain that the locking tab snaps in place.

**IMPORTANT:** This appliance contains Ni-Cd batteries. The batteries must be recycled or disposed of in accordance with local regulations. Please consult your Yellow Pages or local recycling center for more information.

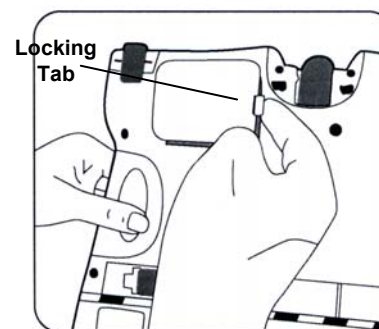

Fig. 10

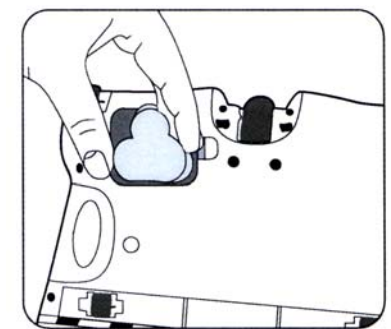

Fig. 11

## CHARGING THE CORDLESS SWEEPER

1. Connect the charger plug to the charging jack or hole on the back of the sweeper. Plug the the charging adapter into the wall outlet. (120V., 60Hz.) Use only TechWorld Charger AD-0720-UL-8 or AD-0815-UL8. (Fig. 9)
2. This cordless sweeper is powered by Ni-Cd batteries. Before first use, they must be charged for a minimum of 20 hours.
3. When recharging the unit, the "On/Off" switch must be in the "OFF" position.
4. The charging light indicator on the top of the sweeper will illuminate to indicate that the sweeper is properly charging.
5. To recharge, repeat step #1 above. Charging times will vary depending upon the amount of usage between charging cycles.

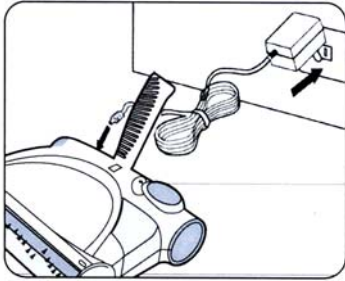

Fig. 9

**NOTE:** If, when you place the sweeper to recharge and the charging indicator light does **NOT** illuminate, then press the On/Off button once to turn the sweeper off. The charging indicator light should now light up.

**NOTE:** Peak performance may only be realized after the unit has been charged and discharged two (2) or three (3) times.

**IMPORTANT:** To maintain peak performance of your cordless sweeper, it is recommended that the unit be fully discharged, then completely re-charged at least once a month.

### **CAUTION**

- Use only with the battery pack supplied with the unit.
- Do not attempt to remove the battery pack from the unit to charge it.
- Never attempt to throw the battery pack or unit into a fire or incinerate it.
- Do not attempt to remove or damage the battery casing.
- Battery must be recycled or disposed of properly at the end of it's service life.

## STORING THE CORDLESS SWEEPER

Your cordless sweeper may be stored by using the slot on the back of the upper handle and hanging it from a screw secured to a wall or other vertical surface. Use a #6 flat or pan head screw with the appropriate hardware for the surface that the sweeper will be mounted on, (i.e. gyproc). Allow the screw head to extend a approximately 3/16" from the mounting surface. Always empty your sweeper before hanging up for storage.

## ASSEMBLING YOUR CORDLESS SWEEPER

### Before you start:

Your Cordless Sweeper will require very little assembly. You should remove it from the carton and familiarize yourself with all the components listed per the exploded view drawing (pg.2) This will help you in the assembly and operation of your cordless sweeper.

**Note:** The charging adapter is shipped inside the dust cup.

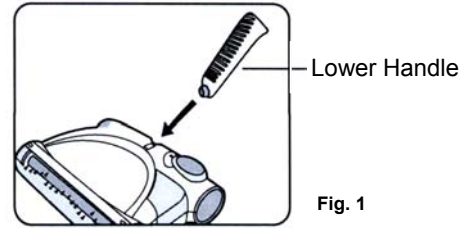

Fig. 1

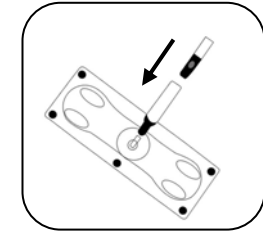

Fig. 2

1. Insert the lower handle - small end - into the sweeper power head, or the floor attachment (Fig.3) Push until firmly in place. (Fig. 1) **HANDLE CAN BE ROTATED FOR PROPER USE.**
2. Assemble the metal extension handles by pushing the plastic insert into the mating metal tube. Push until only small portion of insert is visible or you cannot press any farther into the tubing. Push the handle assembly into the upper handle. **NOTE: One metal extension tube has a different plastic insert. This tube should be on the bottom of the handle.** Insert the handle assembly into the lower handle so that the tab on the plastic insert snaps into the open slot on the lower handle. (Fig. 3)

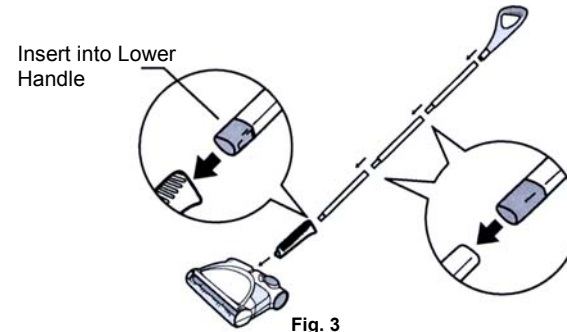

Fig. 3

3. Place the handle into the upward storage position.
4. Plug the charging adapter into the sweeper power head charging jack. Plug the charging adapter cord into a standard electrical outlet (120V, 60Hz.). The green charging indicator should illuminate. If it does not, depress the On/Off switch one time.

**CAUTION: ALWAYS USE ADAPTOR SUPPLIED (ONLY) WITH SWEEPER.**

## HOW TO OPERATE YOUR CORDLESS SWEEPER

1. Before using, please ensure that the cordless sweeper has been initially charged for 20 hours.

Your cordless sweeper will only operate properly when the batteries are fully charged. Your sweeper will operate for varying lengths of time on a full charge. This will depend upon the type of surface being cleaned. (Longer operating time on bare floors vs carpets.)

2. Push the On/Off switch to operate the unit. To turn off, press switch again. (Fig.4)

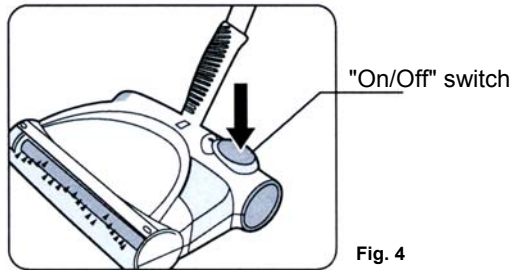

Fig. 4



**CAUTION:** Any electronic or electrical appliance should not be stored in or exposed to areas of high heat or humidity. Do not store your cordless sweeper close to stoves, radiators, furnaces or in a bathroom or bathing area.

3. To release the handle to a comfortable position, apply pressure to the top of the sweeper head with your foot while pulling back on the handle. (Fig. 5)



Fig. 5

## CLEANING THE DUST CONTAINER

To achieve the best performance, empty the dust container after each use.

1. Pull the dust container straight out from the side. (Fig. 6)

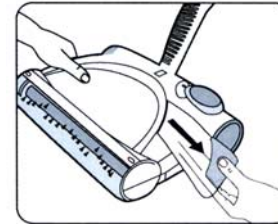

Fig. 6

2. Empty dust container contents. (Fig. 7) If desired- you may rinse with water to clean the dust container - but **dry thoroughly** before replacing on the sweeper.



Fig. 7

3. Replace dust container on cordless sweeper.
4. Periodically remove the transparent brush cover on the front of the cordless sweeper and remove any build up of lint, hair or fiber on the rotating brush. To remove the cover - grip the cover from the bottom, pull out and upward until the cover unlocks from the side slots and tabs located on the top of the sweeper. (Fig. 8)

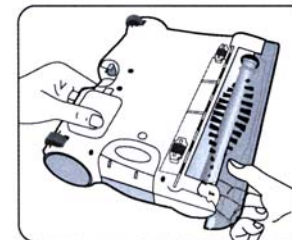

Fig. 8



**CAUTION:** Do not accidentally turn unit on while cleaning. Do not clean while unit is charging.